

HydroLine™

P L U S

Installation and Service Guide

Reverse Osmosis System with Quick-Connect Fittings



**Please read this manual carefully before
the installing the system.**

System and Faucet Installation

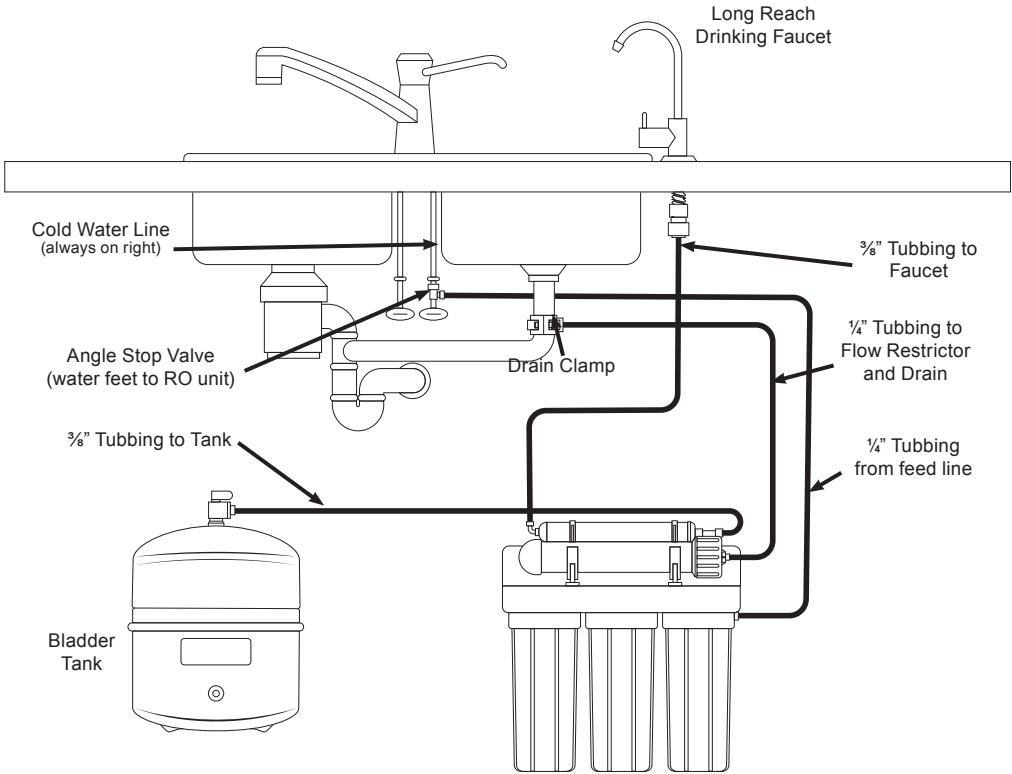

1 Insert tube



2 Push up to tube stop

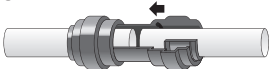

3 Pull to check secure

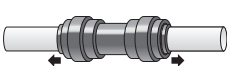

4 Disconnecting

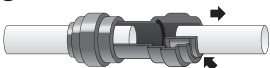

How to make a Quick-Connect Connection

1. Fitting grips before it seals. Ensure tube is pushed into the tube stop.

2. Push the tube into the fitting, to the tube stop. The collet (gripper) has stainless steel teeth which hold the tube firmly in position while the O-ring provides a permanent leak-proof seal.

3. Pull on the tube to check that it is secure. It is a good practice to test the system prior to leaving site and/or before use.

4. To disconnect, ensure the system is depressurized before removing the tube. Push in collet squarely against face of fitting. With the collet held in this position, the tube can be removed. The fitting can then be re-used.

Your Reverse Osmosis (RO) System has been tested to ensure it will operate correctly. The following periodic maintenance is recommended so your system will provide years of trouble-free service:

- Prefilters (sediment) Once per year
- Prefilter (carbon block(s)) Once per year
- RO Membrane Usually Every 2 years
- Postfilter (carbon) Once per year

System Components

The following components make up your reverse osmosis system:

Prefilter #1 (sediment) Melt Blown Polypropylene filter removes larger particles such as dirt, rust & sediment.

Prefilter #2 (& 3 if applicable) 5 Micron Carbon Block removes chlorine and chemical contaminants in the feed water and protects the RO membrane.

Reverse Osmosis Membrane Thin Film Composite Membranes reduces dissolved minerals, metals, and salts.

In this process, harmful compounds are separated by the membrane from the water, and the contaminants are flushed to the drain.

A coconut shell activated carbon postfilter is provided for a final "polish" and to remove tastes, odors and to provide great tasting water.

The RO module is the main component and holds the prefilters and membrane, and postfilter. A bracket is provided so they can be mounted under the sink or in a basement.

Bladder tank holds RO purified water, ready to use.

Automatic shut-off valve closes when the storage tank is full and shuts off the water supply to conserve water. The valve activates when the tank pressure is 2/3 of the feed pressure.

The RO Faucet is used to dispense purified water when you want it.

Feed water saddle valve connects to the cold water line to supply water to the RO system.

Wastewater saddle valve connects to the drain to remove reject water from the RO system.

Tubing connects all RO components.

Quick-Connect fittings are used for necessary tubing connections. These fittings connect by pushing the tube into the fitting past a slight resistance until the tube bottoms out in the fitting. Simply make a clean cut in your tubing and gently push in the tubing until it will not go any further. To ensure that your tubing has made a snug fit, pull back gently on the tubing; it should catch. Always check for leaks to ensure a watertight connection. (see Figure 1)

Tools

The following tools may be necessary, depending on each particular installation:

$\frac{3}{8}$ " variable speed electric drill (2,500 RPM is best for stainless steel); $\frac{3}{8}$ ", $\frac{1}{4}$ " & $\frac{1}{2}$ " metal cutting bits

$\frac{3}{8}$ ", $\frac{1}{4}$ " & $\frac{1}{2}$ " Concrete drill bits (for porcelain sinks)
Phillips head screw driver

6" adjustable wrench

Teflon tape & Plastic tubing cutter Hammer & Center punch

System Location

Your RO system may be installed under a sink or in a basement. Do not install unit where it would be exposed to freezing temperatures. Connecting to an icemaker or other remote location can also be considered if a connection can be made without using more than 12" of tubing, otherwise a delivery pump may be needed. Farther runs can be attempted and a pump can be added later only if needed.

Guidelines for component placement are as follows:

Faucet should be placed on, or near the sink where drinking/cooking water is normally required. A 2" flat surface is required to mount faucet if an existing hole is not available. The thickness of the mounting surface should not exceed $\frac{1}{4}$ " or a faucet extension (not supplied) will be needed.

Bladder Tank maybe placed where it is convenient, within ten feet of the faucet. Under the sink or in a nearby cabinet or in basement rafters are excellent choices. Full tanks can weigh more than thirty pounds; so make sure any shelving used is secure. Bladder tank can be placed on its side or upright.

RO Unit may be mounted on either side of the sink, in the back of a cabinet, or in the basement. Mounting

the unit on the left or the right side of the cabinet under the sink provides for easier access to the unit for future maintenance.

A Faucet Adaptor and Ball Valve Shut-Off are used to supply feed water to the RO unit and provide an easy ability to shut off the water supply when servicing the unit. These are shown in Figure 2.

A Drain Saddle is used to make a wastewater connection with your drain under the sink. This is designed to fit around a standard 1-1/2" OD drainpipe. The drain saddle valve should always be installed before (above) the p-trap and on the vertical or horizontal tailpiece. Do not install the drain saddle near a garbage disposal to avoid clogging the drain line with debris.

Unit preparation

Open shipping carton, remove components and check that all parts are present.

Installation Steps

All plumbing must be completed in accordance with state and local plumbing codes. Some municipalities may require installation by a licensed plumber. Check your local plumbing codes for more information.

Faucet Installation

If the sink has a sprayer, it may be disconnected for faucet installation. A pipe cap or plug will be necessary to seal the sprayer connection or sprayer can be left connected under the sink.

When making the faucet hole (if a sprayer or other existing hole is not being used), check below the sink to make sure the drill will not interfere with anything under the sink. A 2" flat surface on the sink is required for mounting the faucet.

The faucet should be positioned so it flows into the sink and the spout should be allowed to swivel freely for convenience. If an existing hole is being used to mount the faucet, proceed to Step 2.

Installation procedures for Porcelain, Enamel, Ceramic or Metal, or Cast Iron:

Precautions must be taken to penetrate the porcelain through to the metal base and prevent chipping or scratching.

Procedures:

1. Mark the center with center punch for the 1/4" pilot hole.
2. Carefully drill pilot hole with masonry pit through porcelain and stop when metal shows. (Use light pressure and slow speed)
3. Switch the bit to a standard metal cutting bit to continue to cut through the metal below the porcelain surface.
4. Continue to enlarge the pilot hole with larger masonry & metal cutting bits until the hole is 1/2".

Installation procedures for Stainless Steel Sinks:

1. Mark the center with center punch for the 1/4" pilot hole.
2. Drill the pilot hole
3. Continue to enlarge hole with larger size drill bit until it is 1/2".
4. Clean up sharp edges

Note: Air Gap Faucets are required by some munic-

ipalities. These faucets require a 1 1/4" hole in the sink rather than the 1/2" hole required by the standard faucet included with the RO system. To make a 1 1/4" hole to accommodate an air gap faucet requires special tools such as a chassis punch (stainless steel) or a Relton cutter (porcelain) if a large enough hole is not already available. Ask your local dealer for more information.

Note: For granite or marble countertops it is recommended to have an experience professional drill the hole since a specialize diamond drill bit and experience are necessary

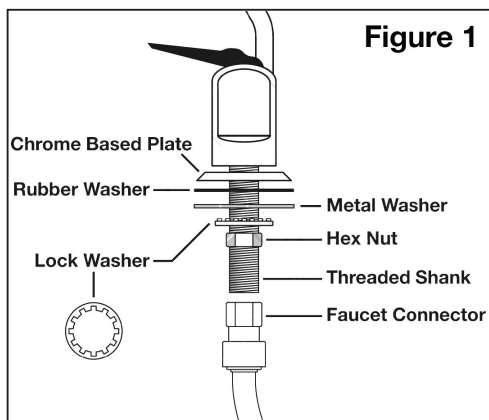

Figure 1

Mounting the Faucet

Disassemble hardware from the threaded shank. Chrome base plates and rubber washers slide up the shank to the faucet body.

Feed threaded shank through the sink hole and orient the faucet. From below sink, slide lock washer and hex nut over threaded shank and tighten with a wrench.

Note: It is best to have someone hold the faucet from above the sink to keep it from moving out of place. If this is not possible then tighten the hex nut until it is just slightly less than completely tight. Then turn the faucet base from above the sink, tightening it while orienting the faucet in the desired location.

John Guest Angle Stop Valve

The John Guest Angle Stop Valve provides a simple, easy connection between the angle stop (cold water shut-off) and the bottom of the riser tube. The Angle Stop Valve has built-in shut-off and provides the feed supply connection for the reverse osmosis system.

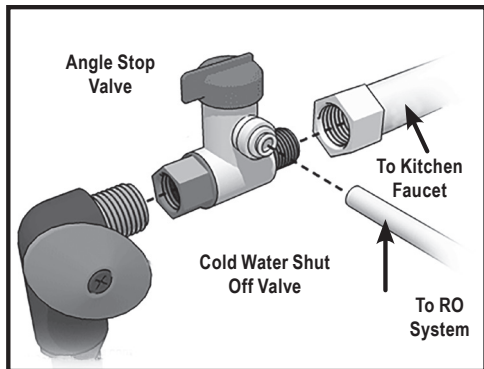

that connect between the faucet and the top of the riser tube.

Please consult your distributor or an installation professional for additional assistance.

Drain Saddle Valve Installation

A Drain Saddle is used to make a wastewater connection with the drain under the sink, which is designed to fit around a standard 1-1/2" OD drainpipe. The drain saddle valve should always be installed before (above) the p-trap and on a vertical or horizontal drain. Do not install the drain saddle near a garbage disposal to avoid clogging the drain line with debris.

Procedures:

1. Shut-off the cold water supply using the angle stop shut-off located under your sink.
2. After shutting off the valve, relieve the pressure by opening the handle on your faucet on the cold water side.
3. Using an adjustable wrench, disconnect the riser tube from the existing cold water shut-off.
4. Move the tubing away from the valve to make room for the John Guest Angle Stop Valve.
5. Connect the swivel end of the John Guest Angle Stop Valve to the threads on the cold water shut-off. This connection should only be hand tight.
6. Connect the riser tube to the male end of the John Guest Angle Stop Valve and tighten with a wrench.
7. Connect a length of 1/4" tubing between the John Guest Fitting on the Angle Stop Valve and the inlet of the RO unit.

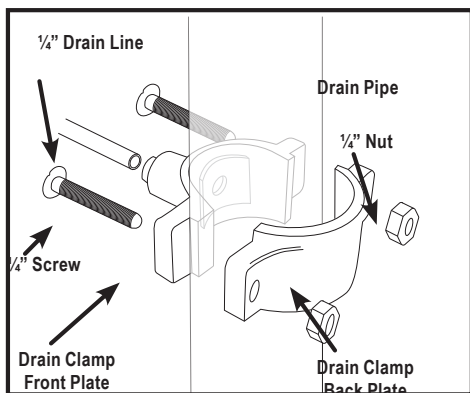

Procedures:

1. Position the drain saddle valve at selected location and mark for the opening.
2. Drill 1/4" hole at mark through one side of pipe.
3. Remove backing from gasket and place adhesive side to the fitting half of drain clamp around hole.
4. Position both halves of drain saddle on drain pipe so the opening aligns with drilled hole. Use a small drill bit to verify that drain clamp is properly aligned.
5. Secure drain saddle clamp on valve with bolts and nuts provided. (Do not over tighten and make sure there is equal space between saddle halves on each side)

Flexible Riser Tubes - Most riser tubes that are used today are made of flexible material, either braided stainless steel, braided plastic or gray 3/8" plastic tubing. These flexible tubes are the easiest to use with the John Guest Angle Stop Valve because the 2" of additional space needed for the Faucet Adaptor can be easily accommodated by flexing this kind of riser. A shorter riser tube will not be needed.

Copper Riser Tubes - If your riser tube is made of copper you will need to either make a bend in the copper to allow for the 2" of space needed for the John Guest Angle Stop Valve. If the copper tube is 3/8", bending it can be done easily by hand.

The John Guest Angle Stop Valve works with 3/8" shut-off valves and riser tubes. In some cases, older plumbing may use a larger size shut-off and riser tube. In this case, it would be necessary to either replace the old valve and riser tube with new 3/8" parts, or use an alternative connection to draw the water supply to the reverse osmosis system. Alternatives include self piercing valves, T fittings, and faucet adaptors

Initial tubing connections

For convenience on under sink installations it may be advisable to complete under sink tubing connections at this time.

RO Component Installation

Install RO membrane O-ring end first, carbon prefilter(s) and sediment pre filter in vertical mounted housings. Be sure RO Membrane is pushed into Membrane housing as far as it will go. It is recommended that filters and membranes be handled with clean or gloved hands.

RO Unit Installation

The RO unit is normally mounted to the right or left sink cabinet sidewall, depending on where supply tank is to be located. Generally the unit is installed at the front of the cabinet and the tank at the rear.

To mount the unit, elevate it at least 2" off the floor, level it and mark the location of mounting holes needed. Drill hole for mounting screws and install screws allowing the mounting bracket slots to slip over them.

Note: If the cabinet sidewalls are not solid, unit may sit on the floor with screws used just to keep it against the cabinet in a vertical position.

Pre-fill & Supply Tank Placement

Pre-filling the storage tank is recommended so there is sufficient pressure to check for leaks and water to flush the carbon post filter. To do this connect the feed line that will serve the RO unit directly to the bladder tank. A 3/8" x

1/4" reducer is provided for this purpose. Allow the water to fill the bladder until it stops. Close the tank valve, shut off the feed pressure, release the tube from the reducer and remove the reducer from the tank valve.

The supply tank should be placed under the counter or within 10 feet of the RO unit.

Note: Tanks are pre-pressurized with air at 7 psi.

Final Tubing Connections

With all components in place, complete final tubing connections with these guidelines:

1. Tubing should follow contour of the cabinets.
2. Cut tubing to correct length using square cuts and a proper cutting tool
3. Make sure there are no crimps in the tubing.
4. Keep tubing from the RO unit to the tank and faucet as short as possible for good flow.
5. The Drain line is a short 1/4" tube connected to the membrane housing. On this tube is a 3" cylindrical drain flow restrictor. This is where the drain line connects to the RO unit. Do not remove the drain flow restrictor as this will cause a failure in the system.

Icemaker hookup (optional and requires a T fitting and additional shut-off valve not supplied with RO unit)

The RO unit can be connected to any standard refrigerator icemaker or ice maker/water dispenser.

(Do not connect to a commercial type bar icemaker)

To complete this operation, connect a T with a shut off valve into the faucet tubing and route tubing to the refrigerator. (Hooking up to existing copper tubing is

not recommended due to possible corrosion) Turn off icemaker inside freezer prior to turning off the existing tap water supply line to the refrigerator. Turn on the icemaker after the RO system has been drained several times and the tank has a full supply of water.

Icemaker lines are often run in the rafters of unfinished basements or finished basements with drop ceilings and then up to the fridge. If the basement has a hard ceiling, this won't be an option and the line would have to be run through cabinets. In cases where a basement or cabinets connecting sink and fridge are not available, icemaker connections cannot be made.

Note: Before any service is performed on the RO system, turn off icemaker valve and icemaker unit. Turn back on only after RO system has been sanitized and flushed out.

System Start-up

Prior to start-up:

Check all fitting connections.

Open ball valve shut-off, allow system to pressurize and check for leaks.

Open valve on bladder tank and open faucet until water flows.

Close faucet, wait five minutes and check for leaks.

Allow system to produce a full tank of RO water. (2-3 hours)

Flushing System and Checking Operation

1. Flip the faucet lever up and this will keep faucet on. Do this and allow tank to completely drain of all water.

! Do not use this water!

2. Close faucet and re-inspect system for leaks.
3. Allow system to produce water for 4 hours, at this point the bladder tank will be full.
4. Open faucet again and allow tank to empty for a second time.

! Do not use this water !

5. Close faucet and allow unit to produce another tank of water.
6. At this point supply line to ice maker connection (optional) may be opened and RO water is ready to be consumed.

Replacing Filters & Sanitizing The System

Each year the filters in the system should be replaced. Usually the membrane can be replaced every other year, but the prefilters and post-filter should be changed annually and in some cases more often.

Filter Replacement

1. Turn off valve on RO bladder tank.
2. Turn off feed water pressure.
3. Open RO faucet to relief pressure.
4. Using the supplied housing wrench remove the filter housing.
5. Discard old filters.
6. Clean filter housings with a cleaning brush
7. Follow sanitizing steps in "Sanitizing the System" section
8. Install new filters in system.
9. Remove and replace GAC Post filter. Remove fittings from old post filter, re-apply Teflon tape and install fittings in new post filter.
10. Turn on feed pressure.
11. Open tank valve.
12. Allow water in tank to flush out post filter and run to drain until empty. Run 2 more complete batches to drain before using water.

Membrane Replacement

1. Remove the supply tube from the end of the membrane housing that has only 1 tube.
2. Unthread the cap from the membrane housing.
3. Remove membrane using a pair of pliers.
4. Clean membrane housing with a brush.

Note: When installing a new membrane be sure to push the membrane into the housing as far as it will go.

Each time the filters are replaced it is recommended that the system be sanitized.

Sanitizing the System

After all filters are removed from the system, housings have been cleaned, tank is empty, and faucet is open...

1. Add 1 gallon of water to a clean bucket.
2. Add 1 teaspoon of unscented household bleach.
3. Add 1 cup of this solution to each filter housing.
4. Tighten filter housings with solution on RO assembly.
5. Connect membrane housing and feed tube.
6. Open tank valve and feed pressure valve.
7. Allow water to fill the RO housing assembly until water comes out of faucet.
8. Close the faucet
9. Allow water to run for 5 minutes.
10. Shut-off feed pressure.
11. Allow solution to stand for 30 minutes.
12. Open faucet and allow system to drain.
13. Remove water from housings before installing new filters and membrane.
14. Install new filters, tighten housings, and reconnect all tubing connections.

15. Open feed pressure valve and check for leaks.
16. Allow the system to make a full tank of water.
17. Run 2 cycles to drain to rinse out sanitizing solution before using water.

Troubleshooting

RO Systems are highly sensitive to pressure and temperature. RO Membranes always perform better under higher pressures. They produce more water, faster, and of better quality with high pressure. The vast majority of problems with RO Systems are a result of low pressure. The effects of low pressure include water constantly running to the drain, slow water production and low water volume available in storage tank. In these cases where low pressure exists, a booster pump will be required.



It is highly recommended that your system be sanitized each year.

On the following page is a table showing RO Membrane performance over a range of temperatures and pressures. Membranes are tested at 65 psi of pressure and temperature of 77 degrees. For each incremental change in either variable, membrane performance changes accordingly. Higher pressures increase production and vice versa.

To troubleshoot a poor performing RO System an accurate measure of the pressure and temperature of water will be required. This will require a pressure gauge to determine exactly what the water pressure is that is feeding the membrane. Descriptions of water pressure such as good, high or strong, unfortunately, are no help in diagnosing an RO System.

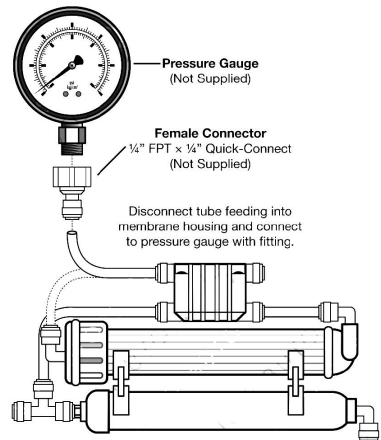

PRESSURE TEMPERATURE CHART

Temp °F	35 PSI	40 PSI	45 PSI	50 PSI	55 PSI	60 PSI	65 PSI	70 PSI	75 PSI	80 PSI	85 PSI	90 PSI	95 PSI	100 PSI	105 PSI	110 PSI
45	0.2321	0.2653	0.2985	0.3316	0.3648	0.3979	0.4311	0.4643	0.4974	0.5306	0.5638	0.5969	0.6301	0.6632	0.6964	0.7296
46	0.2417	0.2762	0.3108	0.3453	0.3798	0.4144	0.4489	0.4834	0.5179	0.5525	0.5870	0.6215	0.6561	0.6906	0.7251	0.7597
47	0.2513	0.2872	0.3231	0.3590	0.3949	0.4308	0.4667	0.5026	0.5385	0.5744	0.6103	0.6462	0.6821	0.7179	0.7538	0.7897
48	0.2609	0.2981	0.3354	0.3726	0.4099	0.4472	0.4844	0.5217	0.5590	0.5962	0.6335	0.6708	0.7080	0.7453	0.7826	0.8198
49	0.2704	0.3091	0.3477	0.3863	0.4250	0.4636	0.5022	0.5409	0.5795	0.6181	0.6568	0.6954	0.7340	0.7726	0.8113	0.8499
50	0.2800	0.3200	0.3600	0.4000	0.4400	0.4800	0.5200	0.5600	0.6000	0.6400	0.6800	0.7200	0.7600	0.8000	0.8400	0.8800
51	0.2896	0.3309	0.3723	0.4137	0.4550	0.4964	0.5378	0.5791	0.6205	0.6619	0.7032	0.7446	0.7860	0.8274	0.8687	0.9101
52	0.2991	0.3419	0.3846	0.4274	0.4701	0.5128	0.5556	0.5983	0.6410	0.6838	0.7265	0.7692	0.8120	0.8547	0.8974	0.9402
53	0.3087	0.3528	0.3969	0.4410	0.4851	0.5292	0.5733	0.6174	0.6615	0.7056	0.7497	0.7938	0.8379	0.8821	0.9262	0.9703
54	0.3183	0.3638	0.4092	0.4547	0.5002	0.5456	0.5911	0.6366	0.6821	0.7275	0.7730	0.8185	0.8639	0.9094	0.9549	1.0003
55	0.3279	0.3747	0.4215	0.4684	0.5152	0.5621	0.6089	0.6557	0.7026	0.7494	0.7962	0.8431	0.8899	0.9368	0.9836	1.0304
56	0.3374	0.3856	0.4338	0.4821	0.5303	0.5785	0.6267	0.6749	0.7231	0.7713	0.8195	0.8677	0.9159	0.9641	1.0123	1.0605
57	0.3470	0.3966	0.4462	0.4957	0.5453	0.5949	0.6444	0.6940	0.7436	0.7932	0.8427	0.8923	0.9419	0.9915	1.0410	1.0906
58	0.3566	0.4075	0.4585	0.5094	0.5603	0.6113	0.6622	0.7132	0.7641	0.8150	0.8660	0.9169	0.9679	1.0188	1.0697	1.1207
59	0.3662	0.4185	0.4708	0.5231	0.5754	0.6277	0.6800	0.7323	0.7846	0.8369	0.8892	0.9415	0.9938	1.0462	1.0985	1.1508
60	0.3757	0.4294	0.4831	0.5368	0.5904	0.6441	0.6978	0.7515	0.8051	0.8588	0.9125	0.9662	1.0198	1.0735	1.1272	1.1809
61	0.3853	0.4403	0.4954	0.5504	0.6055	0.6605	0.7156	0.7706	0.8256	0.8807	0.9357	0.9908	1.0458	1.1009	1.1559	1.2109
62	0.3949	0.4513	0.5077	0.5641	0.6205	0.6769	0.7333	0.7897	0.8462	0.9026	0.9590	1.0154	1.0718	1.1282	1.1846	1.2410
63	0.4044	0.4622	0.5200	0.5778	0.6356	0.6933	0.7511	0.8089	0.8667	0.9244	0.9822	1.0400	1.0978	1.1556	1.2133	1.2711
64	0.4140	0.4732	0.5323	0.5915	0.6506	0.7097	0.7689	0.8280	0.8872	0.9463	1.0055	1.0646	1.1238	1.1829	1.2421	1.3012
65	0.4236	0.4841	0.5446	0.6051	0.6656	0.7262	0.7867	0.8472	0.9077	0.9682	1.0287	1.0892	1.1497	1.2103	1.2708	1.3313
66	0.4332	0.4950	0.5569	0.6188	0.6807	0.7426	0.8044	0.8663	0.9282	0.9901	1.0520	1.1138	1.1757	1.2376	1.2995	1.3614
67	0.4427	0.5060	0.5692	0.6325	0.6957	0.7590	0.8222	0.8855	0.9487	1.0120	1.0752	1.1385	1.2017	1.2650	1.3282	1.3915
68	0.4523	0.5169	0.5815	0.6462	0.7108	0.7754	0.8400	0.9046	0.9692	1.0338	1.0985	1.1631	1.2277	1.2923	1.3569	1.4215
69	0.4619	0.5279	0.5938	0.6598	0.7258	0.7918	0.8578	0.9238	0.9897	1.0557	1.1217	1.1877	1.2537	1.3197	1.3856	1.4516
70	0.4715	0.5388	0.6062	0.6735	0.7409	0.8082	0.8756	0.9429	1.0103	1.0776	1.1450	1.2123	1.2797	1.3470	1.4144	1.4817
71	0.4810	0.5497	0.6185	0.6872	0.7559	0.8246	0.8933	0.9621	1.0308	1.0995	1.1682	1.2369	1.3056	1.3744	1.4431	1.5118
72	0.4906	0.5607	0.6308	0.7009	0.7709	0.8410	0.9111	0.9812	1.0513	1.1214	1.1915	1.2615	1.3316	1.4017	1.4718	1.5419
73	0.5002	0.5716	0.6431	0.7145	0.7860	0.8574	0.9289	1.0003	1.0718	1.1432	1.2147	1.2862	1.3576	1.4291	1.5005	1.5720
74	0.5097	0.5826	0.6554	0.7282	0.8010	0.8738	0.9467	1.0195	1.0923	1.1651	1.2379	1.3108	1.3836	1.4564	1.5292	1.6021
75	0.5193	0.5935	0.6677	0.7419	0.8161	0.8903	0.9644	1.0386	1.1128	1.1870	1.2612	1.3354	1.4096	1.4838	1.5579	1.6321
76	0.5289	0.6044	0.6800	0.7556	0.8311	0.9067	0.9822	1.0578	1.1333	1.2089	1.2844	1.3600	1.4356	1.5111	1.5867	1.6622
77	0.5385	0.6154	0.6923	0.7692	0.8462	0.9231	1.0000	1.0769	1.1538	1.2308	1.3077	1.3846	1.4615	1.5385	1.6154	1.6923
78	0.5480	0.6263	0.7046	0.7829	0.8612	0.9395	1.0178	1.0961	1.1744	1.2526	1.3309	1.4092	1.4875	1.5658	1.6441	1.7224
79	0.5576	0.6373	0.7169	0.7966	0.8762	0.9559	1.0356	1.1152	1.1949	1.2745	1.3542	1.4338	1.5135	1.5932	1.6728	1.7525
80	0.5672	0.6482	0.7292	0.8103	0.8913	0.9723	1.0533	1.1344	1.2154	1.2964	1.3774	1.4585	1.5395	1.6205	1.7015	1.7826
81	0.5768	0.6591	0.7415	0.8239	0.9063	0.9887	1.0711	1.1535	1.2359	1.3183	1.4007	1.4831	1.5655	1.6479	1.7303	1.8126
82	0.5863	0.6701	0.7538	0.8376	0.9214	1.0051	1.0889	1.1726	1.2564	1.3402	1.4239	1.5077	1.5915	1.6752	1.7590	1.8427
83	0.5959	0.6810	0.7662	0.8513	0.9364	1.0215	1.1067	1.1918	1.2769	1.3621	1.4472	1.5323	1.6174	1.7026	1.7877	1.8728
84	0.6055	0.6920	0.7785	0.8650	0.9515	1.0379	1.1244	1.2109	1.2974	1.3839	1.4704	1.5569	1.6434	1.7299	1.8164	1.9029
85	0.6150	0.7029	0.7908	0.8786	0.9665	1.0544	1.1422	1.2301	1.3179	1.4058	1.4937	1.5815	1.6694	1.7573	1.8451	1.9330
86	0.6246	0.7138	0.8031	0.8923	0.9815	1.0708	1.1600	1.2492	1.3385	1.4277	1.5169	1.6062	1.6954	1.7846	1.8738	1.9631
87	0.6342	0.7248	0.8154	0.9060	0.9966	1.0872	1.1778	1.2684	1.3590	1.4496	1.5402	1.6308	1.7214	1.8120	1.9026	1.9932
88	0.6438	0.7357	0.8277	0.9197	1.0116	1.1036	1.1956	1.2875	1.3795	1.4715	1.5634	1.6554	1.7474	1.8393	1.9313	2.0232
89	0.6533	0.7467	0.8400	0.9333	1.0267	1.1200	1.2133	1.3067	1.4000	1.4933	1.5867	1.6800	1.7733	1.8667	1.9600	2.0533
90	0.6629	0.7576	0.8523	0.9470	1.0417	1.1364	1.2311	1.3258	1.4205	1.5152	1.6099	1.7046	1.7993	1.8940	1.9887	2.0834
91	0.6725	0.7685	0.8646	0.9607	1.0568	1.1528	1.2489	1.3450	1.4410	1.5371	1.6332	1.7292	1.8253	1.9214	2.0174	2.1135
92	0.6821	0.7795	0.8769	0.9744	1.0718	1.1692	1.2667	1.3641	1.4615	1.5590	1.6564	1.7538	1.8513	1.9487	2.0462	2.1436
93	0.6916	0.7904	0.8892	0.9880	1.0868	1.1856	1.2844	1.3832	1.4821	1.5809	1.6797	1.7785	1.8773	1.9761	2.0749	2.1737
94	0.7012	0.8014	0.9015	1.0017	1.1019	1.2021	1.3022	1.4024	1.5026	1.6027	1.7029	1.8031	1.9032	2.0034	2.1036	2.2038
95	0.7108	0.8123	0.9138	1.0154	1.1169	1.2185	1.3200	1.4215	1.5231	1.6246	1.7262	1.8277	1.9292	2.0308	2.1323	2.2338

HydroLine™

P L U S

Reverse Osmosis System

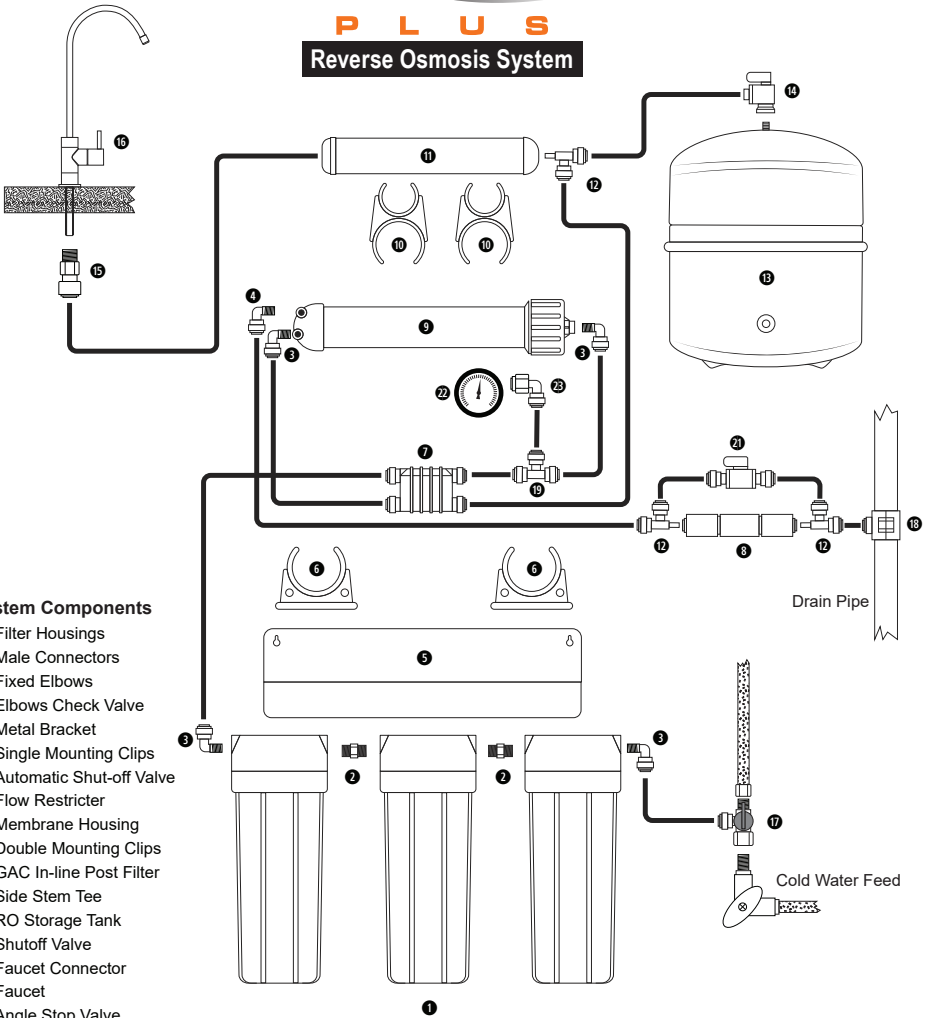

System Components

- ❶ Filter Housings
- ❷ Male Connectors
- ❸ Fixed Elbows
- ❹ Elbows Check Valve
- ❺ Metal Bracket
- ❻ Single Mounting Clips
- ❼ Automatic Shut-off Valve
- ❽ Flow Restrictor
- ❾ Membrane Housing
- ❿ Double Mounting Clips
- ⓫ GAC In-line Post Filter
- ⓬ Side Stem Tee
- ⓭ RO Storage Tank
- ⓮ Shutoff Valve
- ⓯ Faucet Connector
- ⓰ Faucet
- ⓱ Angle Stop Valve
- ⓲ Drain Saddle Clamp
- ⓳ Tee Connector
- ⓴ Stem Elbow
- ⓵ Bypass Straight Valve
- ⓶ Pressure Gauge
- ⓷ Male Elbow Connector

MANUAL MEMBRANE FLUSH

To manually flush the system, follow these 9 steps:

- 1) Locate and close the tank ball valve
- 2) Open the faucet handle
- 3) Locate the flush ball valve behind the membrane housing connected to the drain line.
- 4) Rotate the flush ball valve to the FLUSH position (valve Opened Position)
- 5) You should hear fast water flushing down the drain
- 6) Allow it to flush for 5 minutes
- 7) Open the tank ball valve
- 8) Close the faucet handle
- 9) Return the flush ball valve to IN SERVICE position (valve Closed Position)

Flushing Mode – valve open

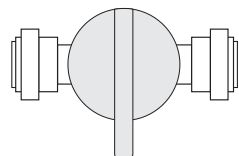
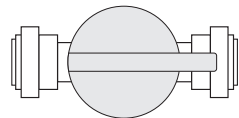

In Service Mode – valve closed

LIMITED PRODUCT WARRANTY

Scope

Hydroline Plus warrants to the original purchaser for a period of five (5) years from the date of purchase, the system will be reasonably free of defects in materials and workmanship. Within that five (5) years period from the original purchase, Hydroline Plus will, at its option, repair or replace the system, or part of the system, without charge, or refund the cost of the Product, if the Product fails or does not perform as warranted solely due to a manufacturing defect within the warranty period, subject to the limitations and exclusions set forth in this Limited Product Warranty. This Limited Product Warranty only applies when the Product is used, stored, handled, and/or installed in the manner recommended by Hydroline Plus User Manual.

Repair or Replacement

Repair or replacement during this five (5) years warranty shall include reasonable labor charges necessary to repair or replace the defective Product but shall not include freight charges or any other local labor charges from third parties other than Hydroline Plus, unless Hydroline Plus expressly approves such charges in writing. During the entire five (5) years warranty period, Hydroline Plus's obligation to repair or replace shall further be limited to repair or replacement with the styles, models, products, colors, etc. of the Product that are available at the time of the repair or replacement and shall be limited to the repair or replacement of only the specific Product that fails due to a manufacturing defect. Any repaired or replaced product shall also remain subject to the original five (5) year warranty from the date of the original purchase, and any repair or replacement shall not extend the original warranty period in any manner or start a new warranty period.

Conditions of Validity of this Limited Product Warranty

Even though the Product has extremely high endurance for operating conditions such as pH, maximum TDS, and optimum water pressure, **THIS LIMITED PRODUCT WARRANTY SHALL ONLY BE VALID IF:**

1. The replaceable filters and membrane are changed and maintained on a regular basis as directed in the Manual. Moreover, depending on local water input water quality, regular maintenance may need to be increased.
2. The Product is operated within the confines of the following standard operating conditions:

	Water Pressure	pH Range	Max. TDS	Water Temperature	Max Turbidity	Max Iron
Standard System	40- 85 psi	2-11	2000 ppm	40-100 F	1.0 NTU	0.1 mg/L
System with Booster Pump	0- 30 psi	2-11	2000 ppm	40-100 F	1.0 NTU	0.1 mg/L

Any information or suggestion by Hydroline Plus with respect to the Product concerning applications, specifications or compliance with codes and standards is provided solely for your convenient reference and is made without any representation as to accuracy or suitability. You must verify and test the suitability of any information with respect to the Product for your specific application.

Non-Covered Defects

THIS LIMITED PRODUCT WARRANTY DOES NOT COVER DEFECTS CAUSED BY:

1. Improper storage, installation, maintenance, handling, and/or alterations of the Product, including, but not limited to, non-compliance with the installation, maintenance and standard operation conditions stated in the Manual and this Limited Product Warranty.
2. Unreasonable use, unintended use, or misuse of the Product for something other than its intended purpose as a reverse osmosis system.
3. Use of replacement parts, filters, membranes or other accessories that are not approved or manufactured by Hydroline Plus for use with this particular Product.
4. Damage not resulting from manufacturing defects that occur while the Product is in the original purchaser's possession.
5. Installation of the Product with known or visible defects at the time of installation.
6. Damage caused by freezing, flood, fire or Act of God.

CONDITIONS THAT RENDER THIS LIMITED PRODUCT WARRANTY VOID

THIS LIMITED PRODUCT WARRANTY SHALL BE VOID IF:

1. The Product is not operated in compliance with normal municipal water conditions for which the particular model of this Product is intended.
2. The person seeking to invoke the warranty is not the original purchaser. That is, this Limited Product Warranty only extends to original purchasers.
3. The is purchased used. That is, this Limited Product Warranty only covers new products.
4. The Product is purchased from someone other than Hydroline Plus or one of Hydroline Plus's authorized dealers. This is because, unless the Product was sold by Hydroline Plus or one of its authorized dealers, Hydroline Plus cannot verify or guarantee the integrity or authenticity of the Product.

General Conditions

The warranties set forth herein are the only warranties made by Hydroline Plus in connection with the product. Hydroline Plus cannot and does not make any implied or express warranties with respect to the product, and disclaims all other warranties, including, but not limited to, any warranty of merchantability or fitness for a particular purpose. Products sold by Hydroline Plus are sold only to the specifications specifically set forth by Hydroline Plus in writing. Other than the limited product warranty set forth herein, Hydroline Plus makes no other warranties, express or implied. Hydroline Plus's sole obligation under this warranty shall be repair or replacement of a non-conforming product or parts of the product, or at the option of Hydroline Plus, return of the product and a refund of the purchase price. Buyer assumes all risk whatsoever as to the result of the use of the product purchased, whether used singularly or in combination with any other products or substances.

No claim by the buyer/owner of any kind, including claims for indemnification, shall be greater in amount than the purchase price of the products in respect to which damages are claimed. In no event shall Hydroline Plus be liable to buyer/owner in tort, contract or otherwise, for any special, indirect, incidental, consequential, reliance, statutory, special, punitive or exemplary damages, including, but not limited to, lost profits, loss of use, loss of time, inconvenience, damage to good will or reputation, or loss of data, even if advised of the possibility of such damages or such damages could have been reasonably foreseen, in connection with, arising out of, or as a result of, the sale, delivery, servicing, use or loss of use of the products sold hereunder, or for any liability of buyer to any third party with respect thereto.

Obtaining Warranty Coverage or General Inquiries

If coverage is available, you may obtain coverage under this Limited Product Warranty by providing Hydroline Plus with proof of original purchase, and that you are the original purchaser. For service under this Limited Product Warranty, you must notify Hydroline Plus by phone at 1-888-903-3777, by email at info@water.industries, or in writing at 10700 Corporate Drive, Suite 124, Stafford, TX 77477. In making the claim, please provide your name, address, phone number, a description of the product involved, product serial number, and an explanation of the claimed defect.

